

Paperless Recorder

Supmea

 www.supmea.com

Supmea Automation Co.,Ltd.

Preface

Thank you for purchasing paperless recorder. Please read this manual carefully before operating and using it correctly to avoid unnecessary losses caused by false operation.

Note

- Modification of this manual's contents will not be notified as a result of some factors, such as function upgrading.
- We try our best to guarantee that the manual content is accurate, if you find something wrong or incorrect, please contact us.
- This product is forbidden to use in explosion-proof occasions.

Version

U-R2-MYEN2

Safety Precautions

In order to use this product safely, be sure to follow the safety precautions described.

About this manual

- Please submit this manual to the operator for reading.
- Please read the operation manual carefully before applying the instrument. On the precondition of full understanding.
- This manual only describes the functions of the product. The company does not guarantee that the product will be suitable for a particular use by the user.

Precautions for protection, safety and modification of this product

- To ensure safe use of this product and the systems it controls, Please read carefully the operation manual and understand the correct application methods before putting into operation, to avoid unnecessary losses due to operation mistakes. If the instrument is operated in other ways not described in the manual, the protections that the instrument give may be destroyed, and the failures and accidents incurred due to violation of precautions shall not be borne by our company.
- When installing lightning protection devices for this product and its control system, or designing and installing separate safety protection circuits for this product and its control system, it needs to be implemented by other devices.
- If you need to replace parts of the product, please use the model specifications specified by the company.
- This product is not intended for use in systems that are directly related to personal safety. Such as nuclear power equipment, equipment using radioactivity, railway systems, aviation equipment, marine equipment, aviation equipment and medical equipment. If applied, it is the responsibility of the user to use additional equipment or systems to ensure personal safety.

-
- Do not modify this product.
 - The following safety signs are used in this manual:



Hazard, if not taken with appropriate precautions, will result in serious personal injury, product damage or major property damage.



Warning: Pay special attention to the important information linked to product or particular part in the operation manual.



- Confirm if the supply voltage is consistent with the rated voltage before operation.
- Don't use the instrument in a flammable and combustible or steam area.
- To prevent from electric shock, operation mistake, a good grounding protection must be made.
- Thunder prevention engineering facilities must be well managed: the shared grounding network shall be grounded at is-electric level, shielded, wires shall be located rationally, SPD surge protector shall be applied properly.
- Some inner parts may carry high voltage. Do not open the square panel in the front except our company personnel or maintenance personnel acknowledged by our company, to avoid electric shock.
- Cut off electric powers before making any checks, to avoid electric shock.
- Check the condition of the terminal screws regularly. If it is loose, please tighten it before use.
- It is not allowed to disassemble, process, modify or repair the product without authorization, otherwise it may cause abnormal operation, electric shock or fire accident.
- Wipe the product with a dry cotton cloth. Do not use alcohol, benzine or other organic solvents. Prevent all kinds of liquid from splashing on the product. If the product falls into the water, please cut off the power

immediately, otherwise there will be leakage, electric shock or even a fire accident.

- Please check the grounding protection status regularly. Do not operate if you think that the protection measures such as grounding protection and fuses are not perfect.
- Ventilation holes on the product housing must be kept clear to avoid malfunctions due to high temperatures, abnormal operation, shortened life and fire.
- Please strictly follow the instructions in this manual, otherwise the product's protective device may be damaged.



- Don't use the instrument if it is found damaged or deformed at opening of package.
- Prevent dust, wire end, iron fines or other objects from entering the instrument during installation, otherwise, it will cause abnormal movement or failure.
- During operation, to modify configuration, signal output, startup, stop, operation safety shall be fully considered. Operation mistakes may lead to failure and even destruction of the instrument and controlled equipment.
- Each part of the instrument has a certain lifetime, which must be maintained and repaired on a regular basis for long-time use.
- The product shall be scrapped as industrial wastes, to prevent environment pollution.
- When not using this product, be sure to turn off the power switch.
- If you find smoke from the product, smell odor, abnormal noise, etc., please turn off the power switch immediately and contact the company in time.

Disclaimer

- The company does not make any guarantees for the terms outside the scope of this product warranty.
- This company is not responsible for damage to the instrument or loss of parts or unpredictable damage caused directly or indirectly by improper operation of the user.

No.	Name	Quantity	Note
1	Paperless recorder	1	
2	Manual	1	
3	Certificate	1	

After opening the box, please confirm the package contents before starting the operation. If you find that the model and quantity are incorrect or there is physical damage in appearance, please contact us.

Contents

Chapter 1 Introduction.....	1
1.1 Parameters.....	2
1.2 Input signal.....	2
1.3 Output signal.....	4
1.4 Other parameters.....	4
Chapter 2 Installation & wiring.....	5
2.1 Unpacking.....	5
2.2 Installation.....	6
2.3 Wiring.....	8
2.3.1 Terminals introduction.....	8
2.3.2 Wiring diagram.....	11
Chapter 3 Basic operation.....	12
3.1 Panel components.....	12
3.2 Navigation keys.....	13
3.2.1 Display operation.....	13
3.2.2 Configuration login.....	28
3.2.3 Configuration.....	29
3.2.4 Parameters & setting.....	31
3.2.5 Input of bit number and unit.....	34
Chapter 4 Configuration description.....	40
4.1 Input setting.....	40
4.2 Function setting.....	42
4.2.1 Communication setting.....	42
4.2.2 U disk operation.....	42
4.2.3 Reset operation.....	43
4.3 System setting.....	44
Annex 1: Modbus address and examples.....	45

Chapter 1 Introduction

Fig.1-1 Product appearance



This product integrates many functions such as data measurement, display, processing, alarm and recording in various industrial occasions, with 36 analog signal input channels, 8 relay alarm output, 150mA distribution output (can be accessed by 6 two-wire transmitter, or 2 four-wire transmitter), two RS-485 communication interface, and a USB data dump interface.

The product is integrated with high speed and high performance 32-bit ARM9 microprocessor. The circuit board is coated with "anti-corrosion, moisture-proof, dust-proof". High-performance instrument power has strong anti-interference ability, and can effectively suppress external harmonic interference, greatly improving the stability of the whole machine.

This product can be used in metallurgy, petroleum, chemical, building materials, paper making, electricity, food, pharmaceutical, industrial water treatment and other industries.

1.1 Parameters

Table 1-1 Main parameters

Screen size	7-inch TFT true color LCD display, resolution 800*480, high definition LED backlight
Dimension	Outer dimension: 193mm * 162mm * 144mm Hole dimension: 138.5mm * 138.5mm
Panel thickness	1.5mm~16.0mm
Weight	1.06kg
Power supply	(176~264)V AC, 47~63Hz
Internal storage	128M bytes Flash
External storage	Support USB disk (standard USB2.0 communication interface)
Maximum power consumption	30VA , 15W
Relative humidity	(10~85) %RH (no moisture condensation)
Operating temp.	(0~50)°C
Storage conditions	Temperature (-20~60)°C, relative humidity (5~95)%RH (no moisture condensation)

1.2 Input signal

Table 1-2 DC voltage / current input

Type	Maximum allowable error (%FS)
(1~5) V	±0.1
(0~10) V	
(0~5) V	
(0~100) mV	
(4~20) mA	±0.2
(0~20) mA	
(0~10) mA	
(-20~20) mV	±0.25
(0~20) mV	

Table 1-3 Thermocouple Input (excl. cold junction error)

Type	Range (°C)	Maximum allowable error (°C)
B	600 ~ 1800	±2.4
E	-200 ~ 1000	±2.4
J	-200 ~ 1200	±2.4
K	-200 ~ -100	±3.3
	-100 ~ 1300	±2.0

Table 1-3 Thermocouple Input (excl. cold junction error)

Type	Range (°C)	Maximum allowable error (°C)
S	-50 ~ 100	±3.7
	100 ~ 300	±2.0
	300 ~ 1600	±1.5
T	-200 ~ -100	±1.9
	-100 ~ 380	±1.6
R	-50 ~ 100	±3.7
	100 ~ 300	±2.0
	300 ~ 1600	±1.5
N	-200 ~ 1300	±3.0

Table 1-4 Thermocouple input

Cu50	-50 ~ 140	±1.0
Pt100	-200 ~ 800	±1.0

Note: Special types of thermal resistances can be customized, such as Pt1000, etc.

1.3 Output signal

Table 1-5 Alarm output

Type	Range	Contact type	Contact capacity	Response cycle
Alarm output	0/1	Normally open contacts	2A /250VAC	1 second

1.4 Other parameters

Table 1-6 other parameters

Fuse specification	3.15 A/250V AC, hard-fusing type
Power distribution specification	150mA, 24 VDC
Power failure protection	All data is stored in flash memory to ensure that all historical data and configuration parameters are not lost due to power failure. The real time clock is powered by internal battery after power failure.
Alarm output	Up to 8 channels. The relay is the normally opened contactor, with the contactor capacity of 2A /250VAC (resistive load).
Communication interface	2-way RS-485 communication interface
Communication protocol	Adopting Modbus communication protocol
Sampling period	1s

Chapter 2 Installation & wiring

This chapter describes the detailed methods of installation and wiring of the instrument, which is mandatory for technician to learn when using the instrument for the first time.

Upon arrival of the instrument, operation procedures from unpacking, installation, wiring to the normal operation are as shown in Figure 2-1.

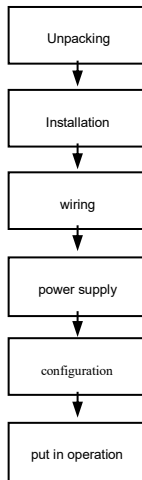

Fig. 2-1 Flowchart from unpacking to putting in operation

2.1 Unpacking

Upon receiving the instrument, first of all, check if the package is intact. Do not apply excessive force to the box when unpacking. The box should face upward. Open it from the seal, and carefully remove the instrument from the box. Make sure the shell is not deformed, damaged or broken. You can check the equipment and other items according to the packing list.

2.2 Installation

Instrument operating environment will not only affect the normal use of the instrument, but also be related to the maintenance and calibration work. Instrument operating environment should meet the following requirements:

- Installation environment: Indoor
- Working temperature: (0~50) °C
- Relative humidity: (10~85) %RH (no moisture condensation)
- Ventilation requirements: good ventilation to avoid excessive internal temperature of instrument.
- Vibration interference: small mechanical vibration.
- Air composition: it is not easy to generate condensed water, no corrosive gas or inflammable gas.
- Inductive interference: no strong inductive interference, not easy to generate static, magnetic or noise interference.
- Instrument Position: keep the level as far as possible when installing the instrument. Do not tilt the left and right sides.

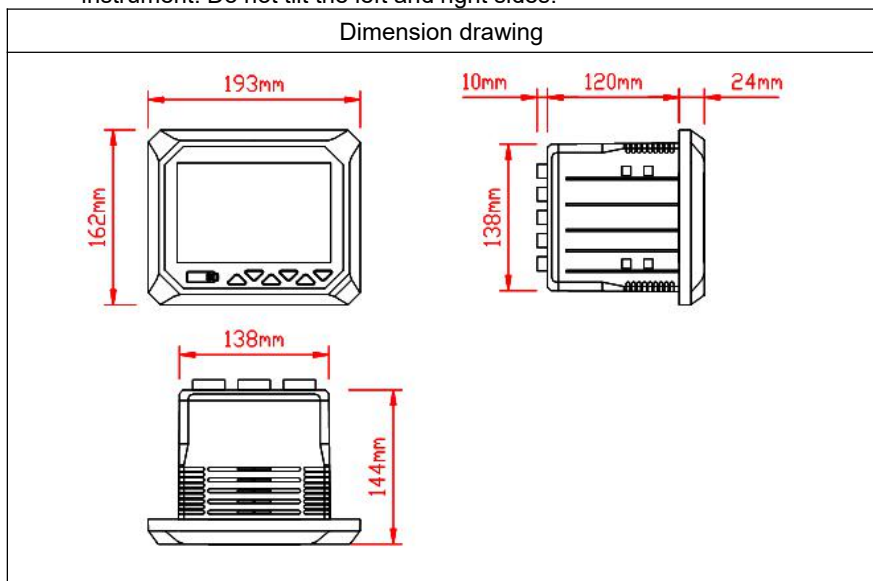

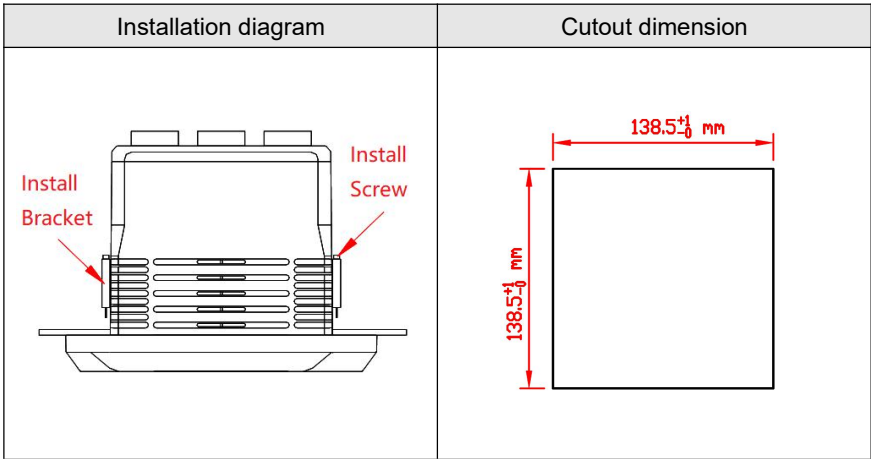

Fig. 2-2 Product Dimension and installation drawing.

2.3 Wiring

In order to improve the stability and accuracy of signal, it must be well grounded.

2.3.1 Terminals introduction

Terminal distribution is shown in Figure 2-3. The specific definition and description of terminal symbols are shown in table 2-1.

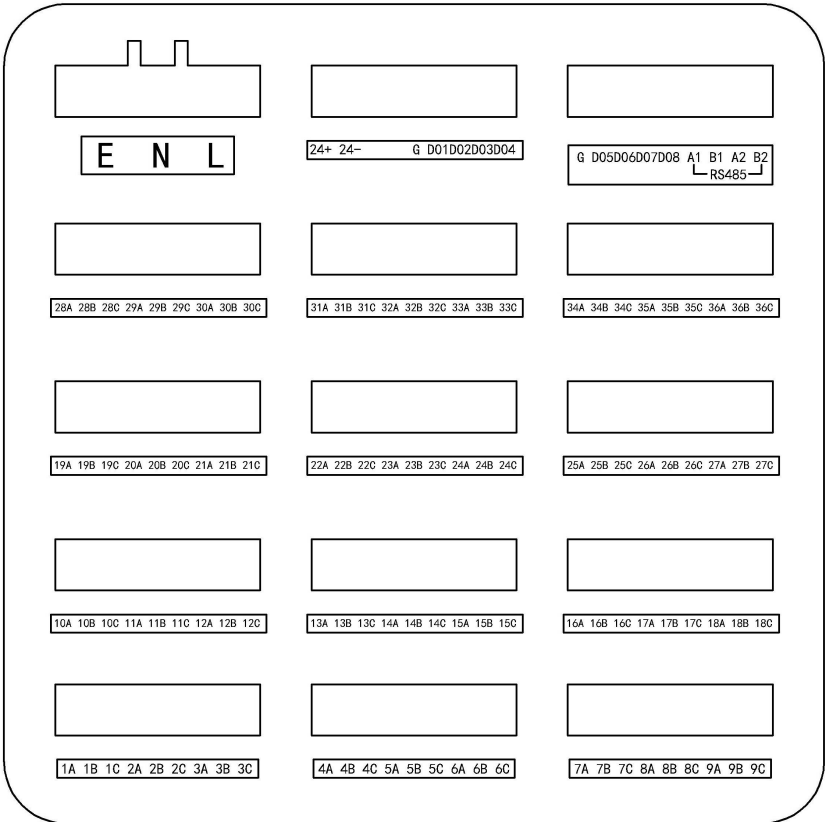

Fig. 2-3 Terminal view

Table 2-1 Specific instructions for each terminal

Terminal sequence number	Signal type	Description
E、N、L	E、N、L	AC power supply (single-phase three-wire system) terminal, L is the phase terminal, N is the neutral terminal, and E is the ground terminal.
Description of Signal input terminal		
1A, 1B, 1C	Universal input	1 st path analog input
2A, 2B, 2C	Universal input	2 nd path analog input
3A, 3B, 3C	Universal input	3 rd path analog input
4A, 4B, 4C	Universal input	4 th path analog input
5A, 5B, 5C	Universal input	5 th path analog input
6A, 6B, 6C	Universal input	6 th path analog input
7A, 7B, 7C	Universal input	7 th path analog input
8A, 8B, 8C	Universal input	8 th path analog input
9A, 9B, 9C	Universal input	9 th path analog input
10A, 10B, 10C	Universal input	10 th path analog input
11A, 11B, 11C	Universal input	11 th path analog input
12A, 12B, 12C	Universal input	12 th path analog input
13A, 13B, 13C	Universal input	13 th path analog input
14A, 14B, 14C	Universal input	14 th path analog input
15A, 15B, 15C	Universal input	15 th path analog input
16A, 16B, 16C	Universal input	16 th path analog input
17A, 17B, 17C	Universal input	17 th path analog input
18A, 18B, 18C	Universal input	18 th path analog input
19A, 19B, 19C	Universal input	19 th path analog input
20A, 20B, 20C	Universal input	20 th path analog input
21A, 21B, 21C	Universal input	21 st path analog input
22A, 22B, 22C	Universal input	22 nd path analog input
23A, 23B, 23C	Universal input	23 rd path analog input
24A, 24B, 24C	Universal input	24 th path analog input
25A, 25B, 25C	Universal input	25 th path analog input
26A, 26B, 26C	Universal input	26 th path analog input
27A, 27B, 27C	Universal input	27 th path analog input
28A, 28B, 28C	Universal input	28 th path analog input
29A, 29B, 29C	Universal input	29 th path analog input

Table 2-1 Specific instructions for each terminal

Terminal sequence number	Signal type	Description
30A, 30B, 30C	Universal input	30 th path analog input
31A, 31B, 31C	Universal input	31 st path analog input
32A, 32B, 32C	Universal input	32 nd path analog input

Table 2-1 Specific instructions for each terminal

Terminal sequence number	Signal type	Description
33A, 33B, 33C	Universal input	33 rd path analog input
34A, 34B, 34C	Universal input	34 th path analog input
35A, 35B, 35C	Universal input	35 th path analog input
36A, 36B, 36C	Universal input	36 th path analog input

Descriptions of communication interface terminal

A1(RS-485)	485+	RS-485 communication interface 1
B1(RS-485)	485-	RS-485 communication interface 1
A2(RS-485)	485+	RS-485 communication interface 2
B2(RS-485)	485-	RS-485 communication interface 2

Description of power distribution terminal

24+	/	24V+
24-	/	24V-

Description of Alarm output terminal

DO1	Relay	Channel 1 of alarm output
DO2	Relay	Channel 2 of alarm output
DO3	Relay	Channel 3 of alarm output
DO4	Relay	Channel 4 of alarm output
DO5	Relay	Channel 5 of alarm output
DO6	Relay	Channel 6 of alarm output
DO7	Relay	Channel 7 of alarm output
DO8	Relay	Channel 8 of alarm output
G		Alarm common

2.3.2 Wiring diagram

<p>mA input (no power distribution)</p> 	<p>mA input (power distribution)</p> 
<p>V/mV input</p> 	<p>Thermocouple Input</p> 
<p>Thermal resistance input</p> 	

Fig. 2-4 Schematic diagram of signal line connection

Chapter 3 Basic operation

Each part is displayed on the panel of paperless recorder as shown in fig.3-1.

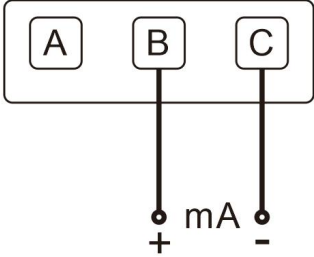
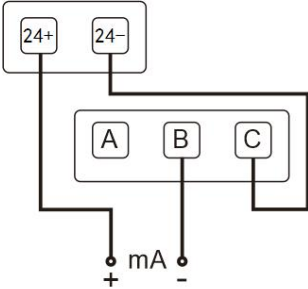
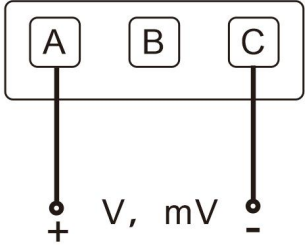
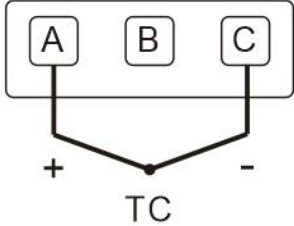
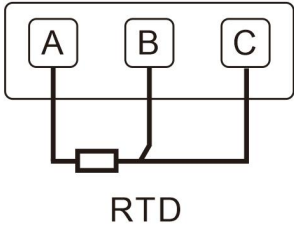

Fig. 3-1 Distribution of components on panel

3.1 Panel components

- LCD picture: display monitoring, configuration and other pages.
- Buttons:

Button	Name	Button	Name
	Increase		Right
	Decrease		Enter
	Left		Cancel

3.2 Navigation keys

3.2.1 Display operation

Prompts column

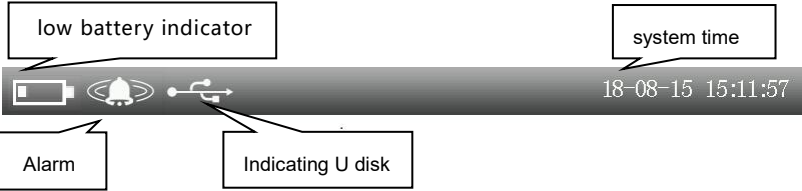

The prompts column displays several indicators: a low battery indicator (battery icon), an alarm indicator (bell icon), and a U disk indicator (USB icon). The system time is displayed as 18-08-15 15:11:57.

- Cattery capacity: replace the battery when it appears, and backup data before replacement.
- Alarm: when there is alarm information, it will disappear after entering the alarm screen.
- U disk indication: appears when U disk is inserted.
- System time: displays the current system time.

Overview

18-08-15 15:11:57					
CH1	CH2	CH3	CH4	CH5	CH6
-	-	-	XXXXXX °C	XXXXXX	XXXXXX
27.8	-	-	-	-	XXXXXX
28.0	28.0	28.0	-	-	-
XXXXXX	XXXXXX	XXXXXX	XXXXXX	XXXXXX	XXXXXX
XXXXXX	XXXXXX	XXXXXX	XXXXXX	XXXXXX	XXXXXX
XXXXXX	XXXXXX	XXXXXX	XXXXXX	XXXXXX	XXXXXX

- Display all bits, instantaneous values, units and alarm status of all analog inputs.
- "XXXXXX" represents the channel disconnection.
- The "+..." and "-..." indicate that V, mV and mA signals are over range.
- Press left / right key, to switch screen.

Digital display (original signal)



- Display bit number, original signal instantaneous value and alarm status of channel.
- Press increase key to switch channel.
- Press left / right key, to switch screen.

Digital display

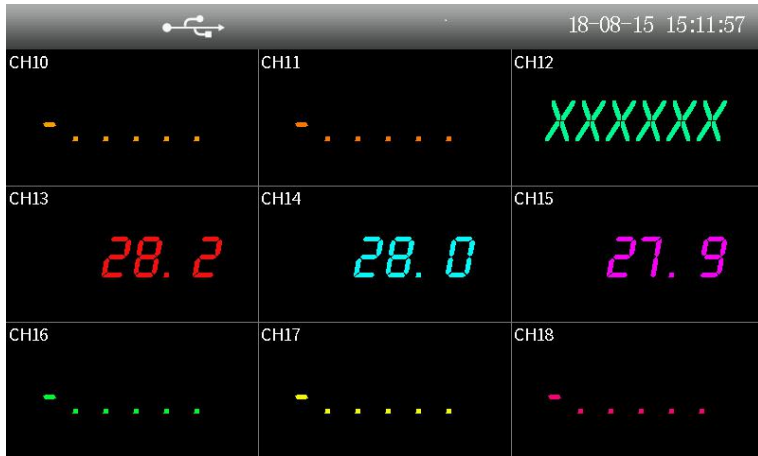

- Display bit number, instantaneous value, unit and alarm status of channel.
- Press increase key to switch channel.
- Press left / right key, to switch screen.

Bar graph (vertical)



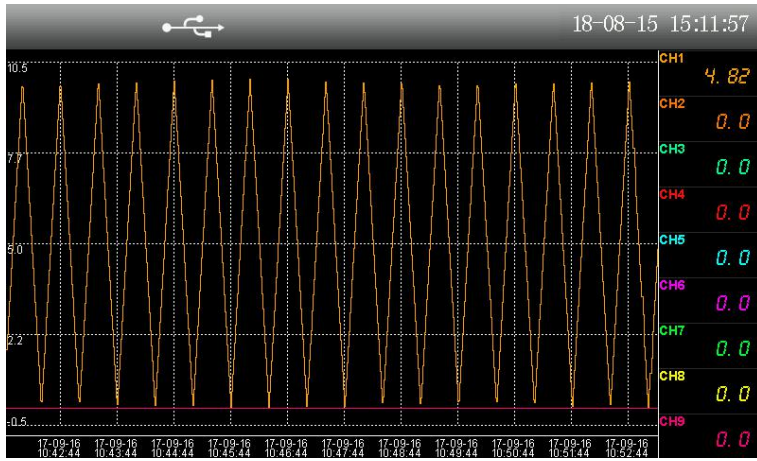

- Display bit number, instantaneous value and alarm status of channel.
- Press increase key to switch channel.
- Press left / right key, to switch screen.

Real time curve



- Display bit number, real-time curve and alarm status of channel.
- Press increase key to switch channel.
- Press left / right key, to switch screen.

Log			
		18-08-15 15:11:35	
NO	Time	Logs	
0011	18-08-15 14:43:29	Save CFG	
0010	18-08-15 14:43:04	Save CFG	
0009	18-08-15 14:39:08	Save CFG	
0008	18-08-15 14:37:51	Save CFG	
0007	18-08-15 14:32:54	Save CFG	
0006	18-08-15 14:32:01	Save CFG	
0005	18-08-15 14:30:52	Save CFG	
0004	18-08-15 14:30:28	Save CFG	
<ul style="list-style-type: none"> ● Display log information. ● Press the increase/ decrease button to review the log information before and after. ● Press Left /Right key, to switch screen. 			
Power off Information			
		18-08-15 15:11:57	
NO	PowOff Time	PowOn Time	Last Time
0007	18-08-15 15:03:27	18-08-15 15:09:51	000h06m24s
0006	18-08-15 14:56:21	18-08-15 14:56:32	000h00m11s
0005	18-08-15 14:54:48	18-08-15 14:55:00	000h00m12s
0004	18-08-15 14:52:36	18-08-15 14:52:48	000h00m12s
0003	18-08-13 10:05:26	18-08-15 14:23:48	052h18m22s
0002	18-08-08 10:51:48	18-08-13 10:05:04	119h13m16s
0001	18-08-08 10:23:56	18-08-08 10:25:12	000h01m16s
00171h39m53s			

- Display power on/off time and accumulated power-off information.
- Press increase/decrease key to review power-off information.
- Press left / right key, to switch screen.

Alarm

		18-08-15 15:13:20		
NO	Channel	Type	Alm Start	Alm Stop
20	CH36	LL	18-08-15 14:30:57	XX-XX-XX XX:XX:XX
19	CH36	Lo	18-08-15 14:30:57	XX-XX-XX XX:XX:XX
18	CH35	LL	18-08-15 14:30:57	XX-XX-XX XX:XX:XX
17	CH35	Lo	18-08-15 14:30:57	XX-XX-XX XX:XX:XX
16	CH34	LL	18-08-15 14:30:57	XX-XX-XX XX:XX:XX
15	CH34	Lo	18-08-15 14:30:57	XX-XX-XX XX:XX:XX
14	CH33	LL	18-08-15 14:30:57	XX-XX-XX XX:XX:XX
13	CH33	Lo	18-08-15 14:30:57	XX-XX-XX XX:XX:XX

- Display channel, type, start/end time of alarm.
- Press increase/decrease key to check alarm information.
- Press left / right key, to switch screen.

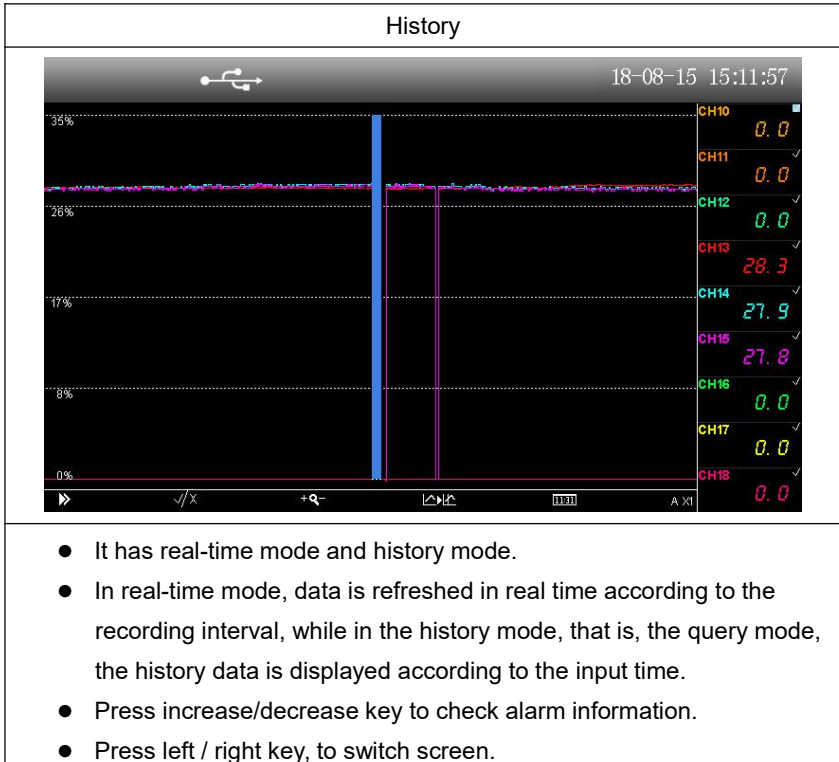

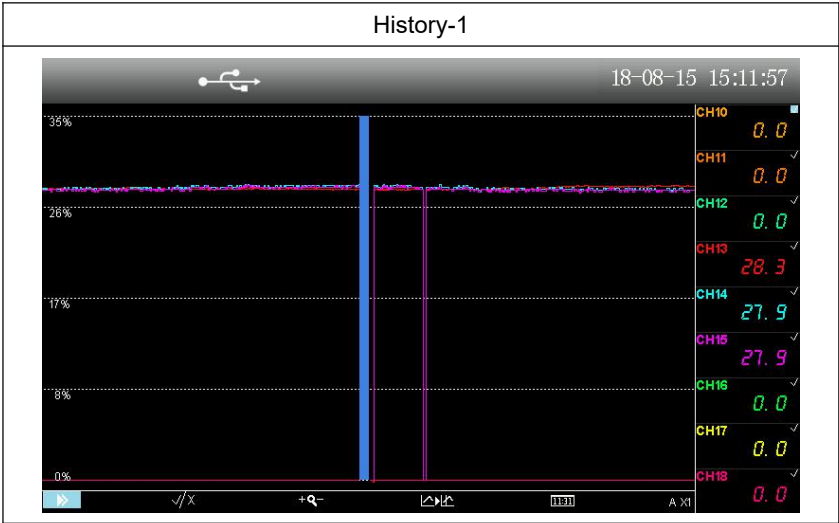

- Press increase key to enter channel switch status.
- At this time, press left / right key, to switch channel. Continue to press increase key to switch to the next status.

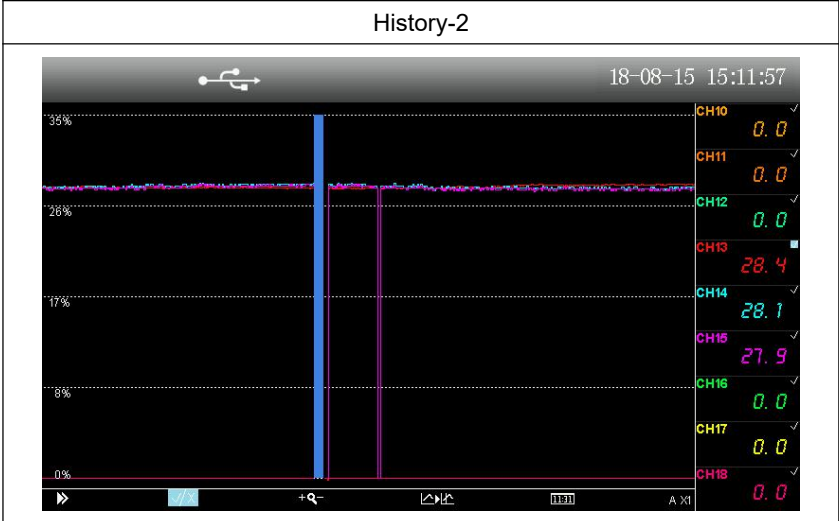

- Press increase key to enter blanking status.
- At this time, press left / right key to choose the blanking channel.

Press ok key to blank or display the chosen curve. Continue to press increase key to switch to the next status.

History-3

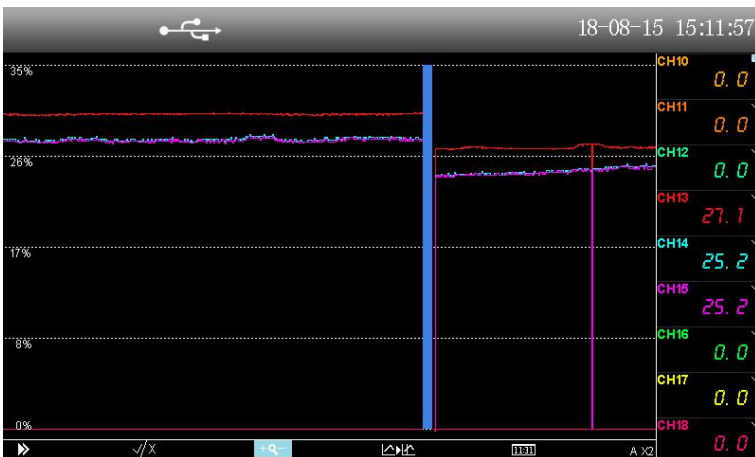

2 times

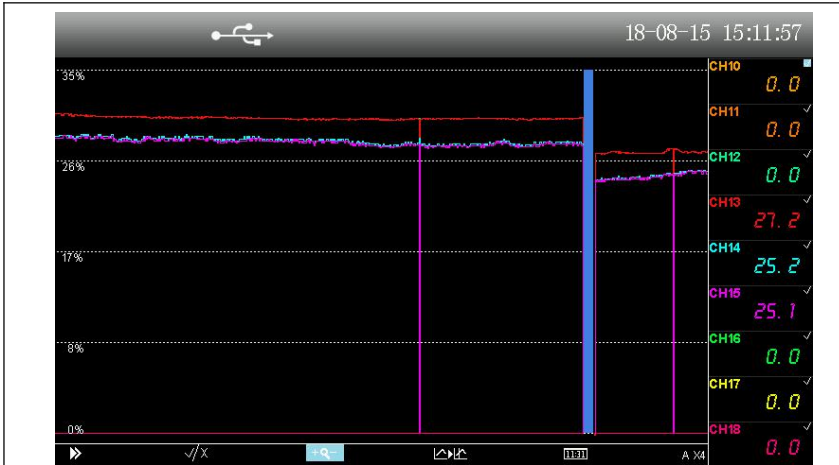

4 times

- Then press the increase key to switch to zoom.
- At this time, the left / right shift key to change zoom multiples out of three options: 1, 2 and 4. Continues to press the Increase key to switch to the next state.

History - 4



“A” in auto status



“M” in manual status

- Press increase key to enter the real-time history switch status.
- At the time, press left/right shift key to change history and real-time status. Continue to press increase key to switch to the next status.

History - 5



- In the history (manual) mode, press increase key again to switch to manual query mode (arrow ).
- At this time, press left / right key can check the value of historical data before and after, long press to move quickly.
- ● Continue to press increase key to switch to the next state.

History - 6

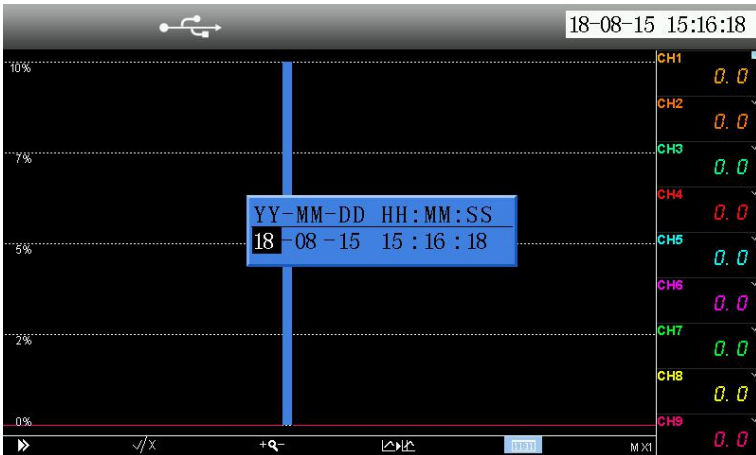
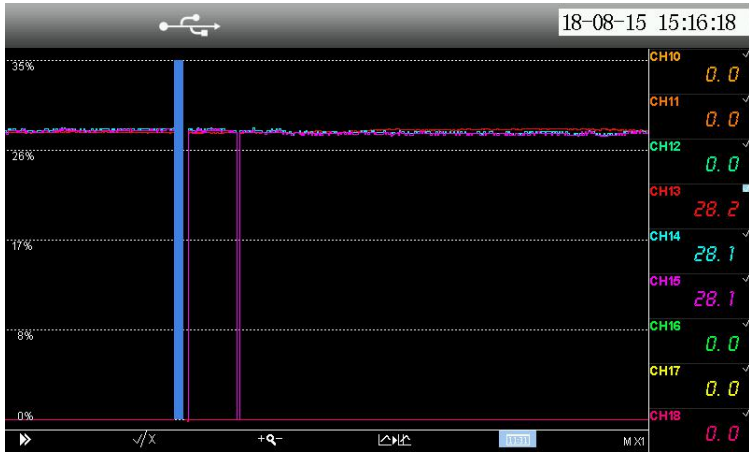

- Press Increase button again to switch to the fixed point query mode. At this time, press OK button to pop up the time setting.
- Continue to press increase button to exit the history screen operation status.
- After setting the time, press the OK button to query.

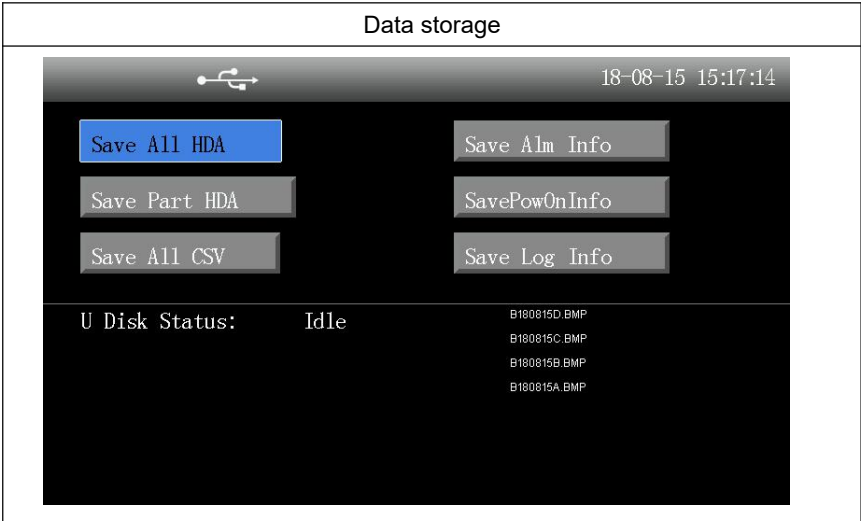

- Save historical data in HDA and CSV format
- Save alarm information, power-off records and log records in CSV form
- The saved list is in the right bottom.

Data storage -1

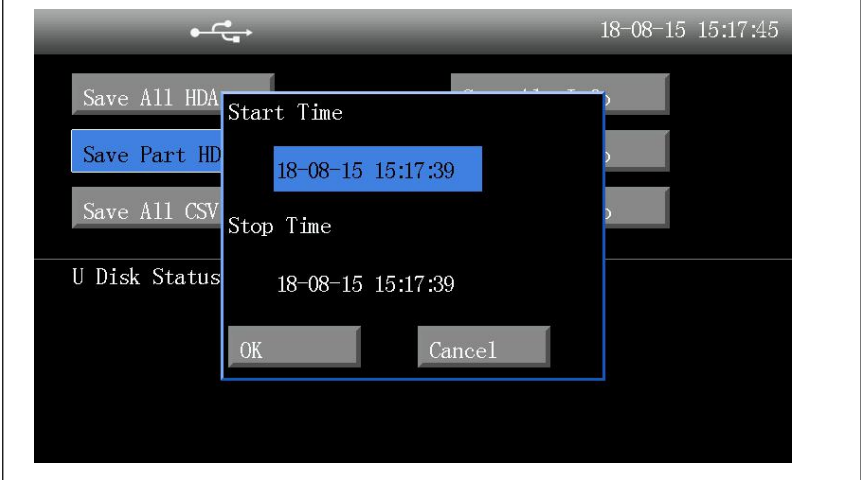

- Set start time and stop time to save part of historical data in HDA format.

File storage path:

The instrument files are stored in the USB root directory [instrument name] corresponding folder. [Instrument Name] is changed in the "System Settings" configuration.

File name:

File	Subdirectory	File name
History	/History	H180815A.csv/ H180815A.hda
Cumulative Report	/Info	A180815A.csv
Alarm information	/Info	B180815A.csv
Power-off record	/Info	P180815A.csv
Log record	/Info	L180815A.csv

Whereas:

The initials H, A, B, P and L represent file types.

The last six number indicates the date saved.

The last letter can be A ~ Z, which indicates that a type can be saved to 26 times a day, but cannot be saved if it is full.

Tip: If the system detects a U-disk insert, the data will be automatically transferred to the U-disk at 2:00 a.m. every day.

3.2.2 Configuration login

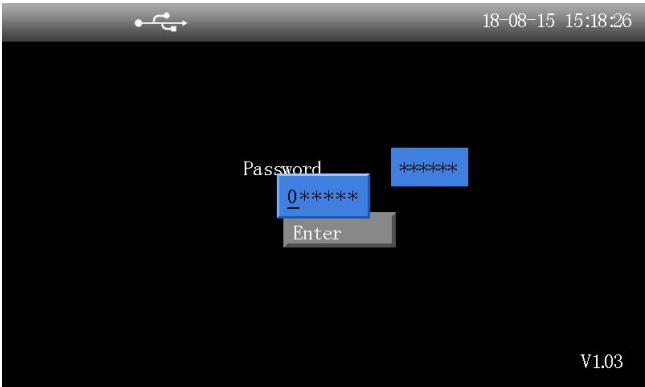
Step	Operation
1	<ul style="list-style-type: none"> ● Long press increase key and left shift key in the monitoring screen to enter configuration login. 
2	<ul style="list-style-type: none"> ● Press left / right shift key to select the entry, press Enter key to input the password. ● Press increase/decrease key to change password. Press enter key to confirm the input. 
3	<ul style="list-style-type: none"> ● Confirm the password is correct. Select [enter configuration] and press enter key to login configuration.

3.2.3 Configuration

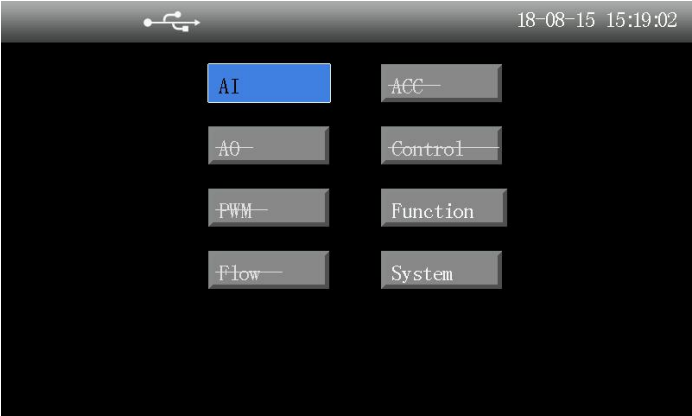
Step	Operation
1	<ul style="list-style-type: none"> After modification, press cancel key till entering configuration selection. 
2	<ul style="list-style-type: none"> Press cancel key again. If configuration is changed, a confirmation frame will pop up. If not, it enters directly into monitoring page.

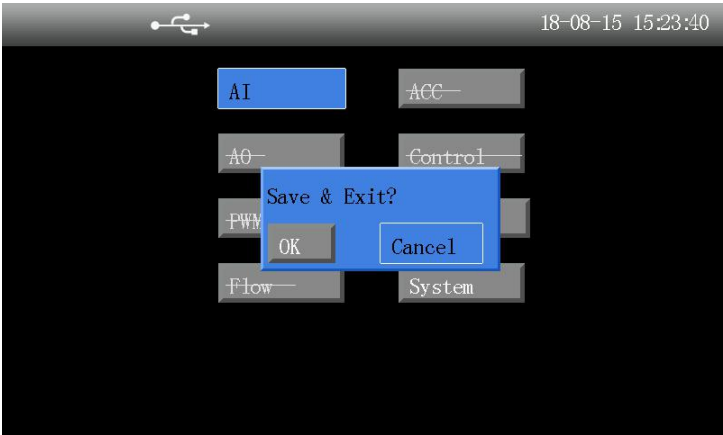
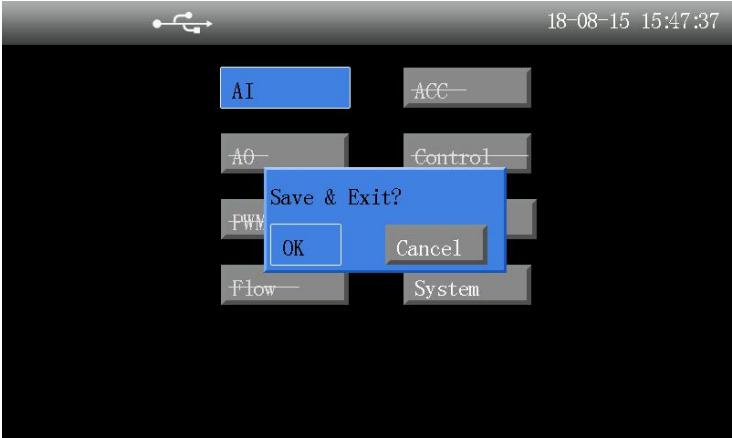
	
3	<ul style="list-style-type: none">● Select [enter] and press enter key. <p>Note: select [cancel] as default.</p>
	

3.2.4 Parameters & setting

Number input

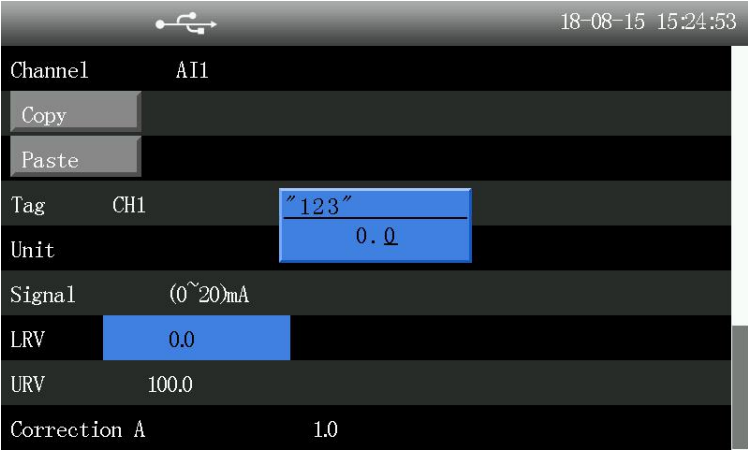
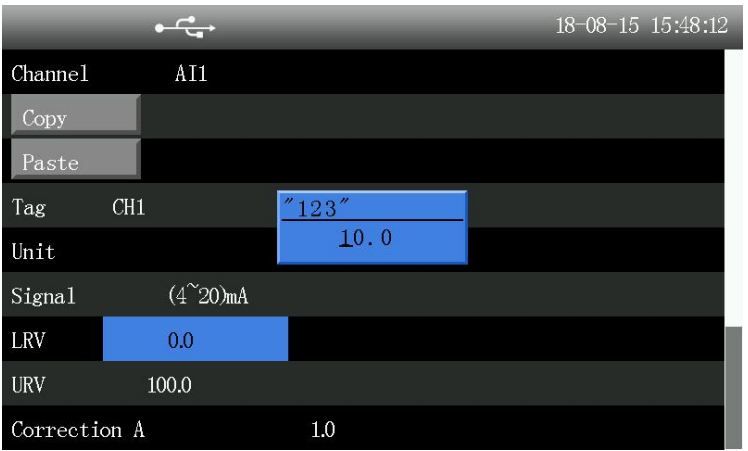
Step	Operation
1	<ul style="list-style-type: none"> Select parameters to be modified, and press enter key. 
2	<ul style="list-style-type: none"> Press left/right shift key to select the location to be modified. 

● Press increase/decrease key to modify the number at the location.

3

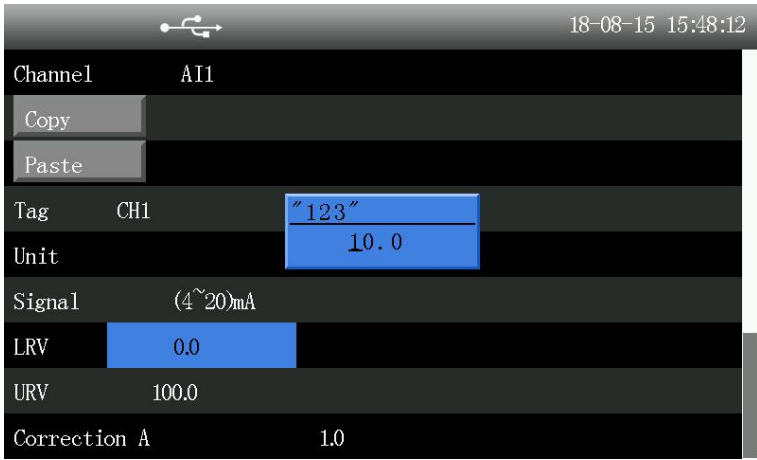

The screenshot shows a menu with the following items: Channel AI1, Copy, Paste, Tag CH1 (with a blue input field containing "123"), Unit (with a blue input field containing "10.0"), Signal (4~20)mA, LRV (with a blue input field containing "0.0"), URV 100.0, and Correction A 1.0. The top status bar shows a USB icon and the date/time 18-08-15 15:48:12.

● Press enter key to adjust decimal point after input is done.

4

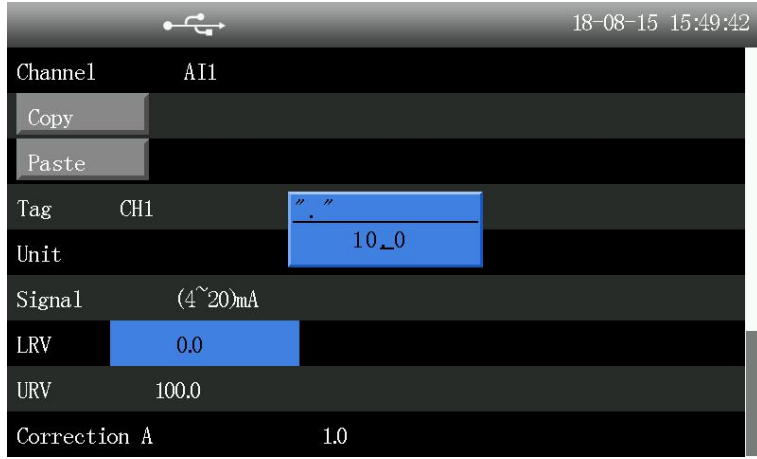

The screenshot shows the same menu as above, but the Unit field now contains "10_0" (with a blue input field containing ".") and the Tag field contains "". The top status bar shows the date/time 18-08-15 15:49:42.

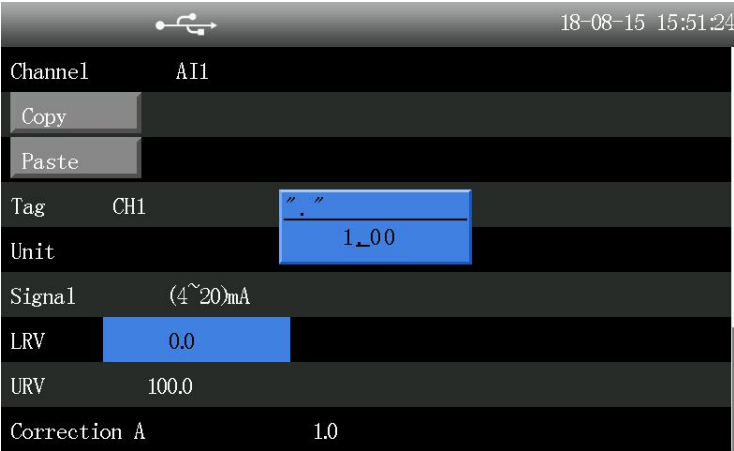
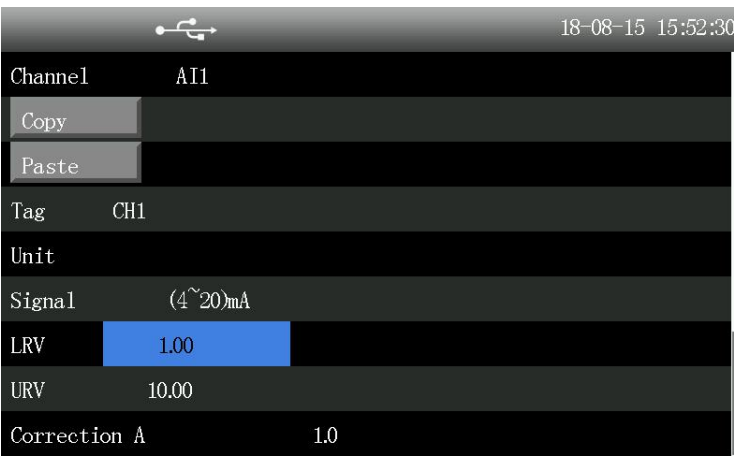
5	<ul style="list-style-type: none"> ● Press left/right shift key to modify the location of decimal point.
	 <p>The screenshot shows the device's main menu with the following fields: Channel (AT1), Tag (CH1), Unit, Signal ((4~20)mA), LRV (0.0), URV (100.0), and Correction A (1.0). The LRV field is highlighted in blue, and a small blue box shows the decimal point being moved from the first to the second position, changing the value to 1.00.</p>
6	<ul style="list-style-type: none"> ● Press enter key again, to complete number input. ● Press cancel key to cancel the modification.  <p>The screenshot shows the device's main menu with the following fields: Channel (AT1), Tag (CH1), Unit, Signal ((4~20)mA), LRV (1.00), URV (10.00), and Correction A (1.0). The LRV field is highlighted in blue, and the decimal point is now in the second position, changing the value to 1.00.</p>

3.2.5 Input of bit number and unit

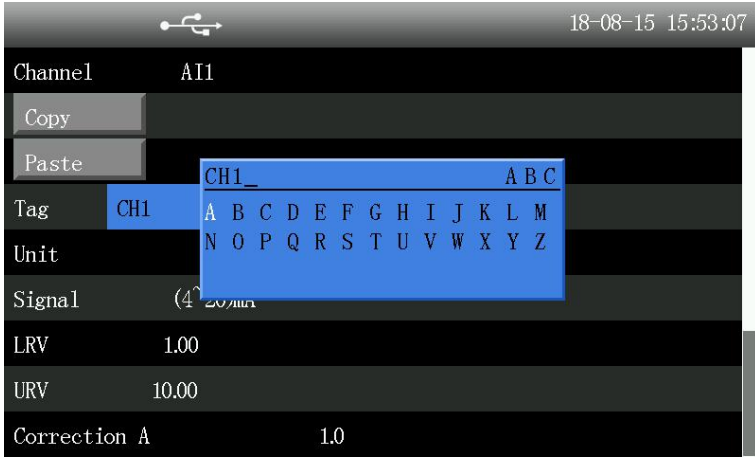
Step	Operation
1	<ul style="list-style-type: none"> Select parameters to be modified, and press enter key. 
2	<ul style="list-style-type: none"> Press increase key to switch the type of input character. 

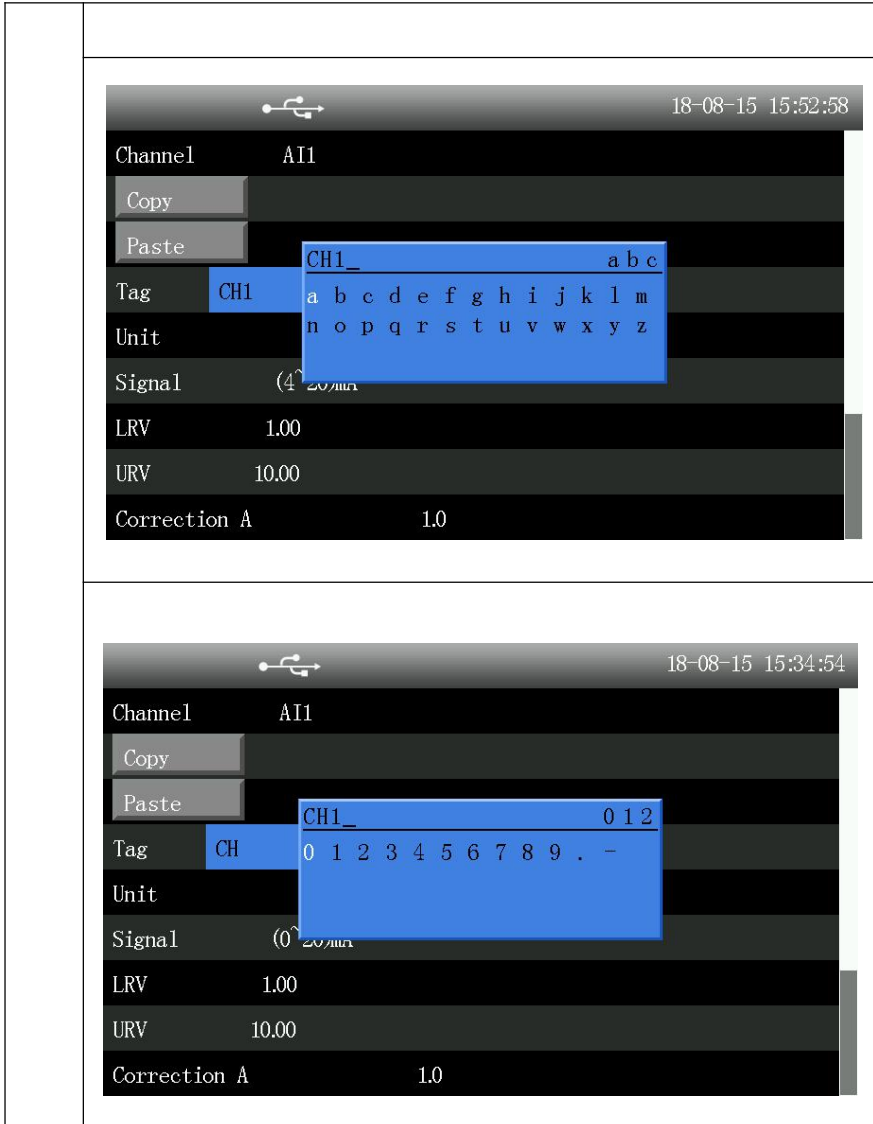

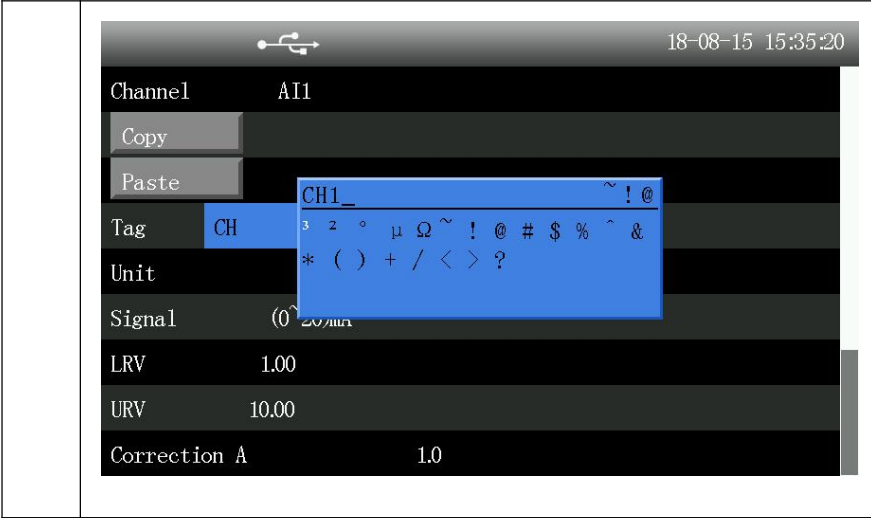

- Press left / right shift key to select the input character
- Press enter key to confirm the input
- Press decrease key to delete the input
- Press cancel key to save and exit

3

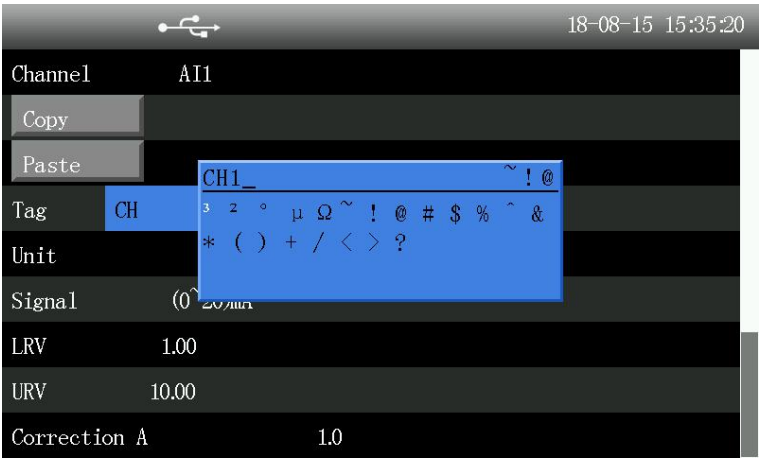

Selection frame

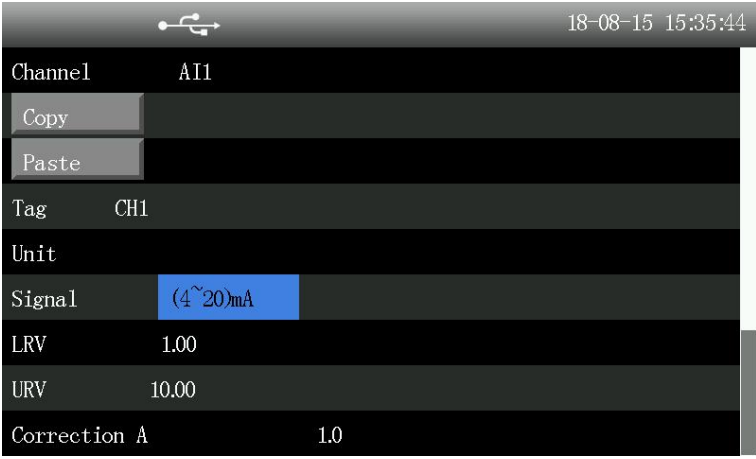
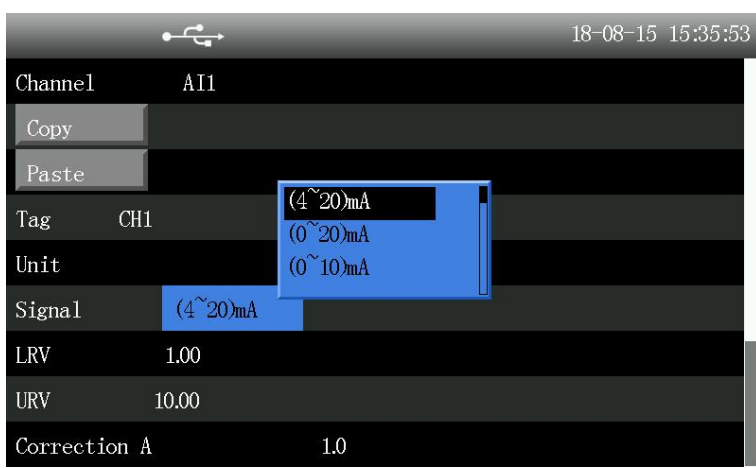
Step	Operation
1	<ul style="list-style-type: none"> ● Select parameters to be modified, and press enter key. 
2	<ul style="list-style-type: none"> ● Press left / right shift key to select the entry. ● Press enter key to save and exit. ● Press cancel key to cancel exit. 

System time

Step	Operation
1	<ul style="list-style-type: none"> ● Select the parameters to be modified and press enter key. ● Press left / right shift key to select location. ● Press up/down key to change number. ● Press enter key to save and exit. ● Press cancel key to cancel exit.  <p>The screenshot shows a settings menu with the following items:</p> <ul style="list-style-type: none"> USB icon and date/time: 18-08-15 16:13:33 Password: **** Device ID: 2FWJDF12 Sys Time: 18-08-15 16:13:33 (highlighted) Time Format: YY-MM-DD HH:MM:SS (highlighted) Rec Interval: 18-08-15 16:13:30 (highlighted) Y-axis: Percent Language: English Default Pic: All Datas Group Circle: 0sec

Instrument name

Step	Operation
1	<ul style="list-style-type: none"> ● Select the parameters to be modified and press enter key. ● Press left / right shift key to select location. ● Press increase/decrease key to change letter. ● Press enter key to save and exit. ● Press cancel key to cancel exit. <div style="border: 1px solid black; padding: 5px; margin-top: 10px;">  </div>

Tips: press increase/decrease key in [input setting] to switch channel directly.

Chapter 4 Configuration description

This chapter describes each configuration parameter of the instrument.

4.1 Input setting

Configuration item description:

Configuration item	Function descriptions	Parameter range
Channel	Select analog channel for setting	AI1~AI36 (prevail in actual display)
Copy	Copy current channel configuration information	
Paste	Paste copied configuration information	
Bit number	Select bit number for analog channel	Self-defined character string, length:8
Unit	Select unit for analog channel	Self-defined character string, length:8
Signal	Set signal type	(4~20)mA, (0~20)mA、(0~10)mA, Pt100, Cu50, (1~5)V, (0~10)V, (0~5)V, B, E, J, K, S, T, R, N, (0~20)m, (-20~20)mV, (0~100)mV
Range lower limit	Set range lower limit	-99999~99999
Range upper limit	Set range upper limit	-99999~99999
Correction factor A	A in $Y=A*X+B$	-99999~99999
Correction factor B	B in $Y=A*X+B$	-99999~99999
First-order filter	First-order filter parameter	0s、1s、2s、5s、10s、15s、30s
Disconnection display	Display value when channel is disconnected.	-99999~99999
Alarm setting	Enter alarm setting display.	

Alarm setting:

Configuration item	Function descriptions	Parameter range
High-high alarm HH	High-high alarm value	-99999~99999
High-high alarm delay	High-high alarm delay	0 s, 10 s, 30 s, 60 s, 120 s, 180 s, 240 s.
High-high alarm output	High-high alarm output terminal	None、DO1、DO2、DO3、 DO4、DO5、DO6、DO7、 DO8 (prevail in actual display)
High alarm Hi	High alarm value	-99999~99999
High-high alarm delay	High-high alarm delay	0 s, 10 s, 30 s, 60 s, 120 s, 180 s, 240 s.
High alarm output	High alarm output terminal	None、DO1、DO2、DO3、 DO4、DO5、DO6、DO7、 DO8 (prevail in actual display)
Low alarm Lo	Low alarm value	-99999~99999
Low alarm delay	Low alarm delay	0 s, 10 s, 30 s, 60 s, 120 s, 180 s, 240 s.
Low alarm output	Low alarm output terminal	None、DO1、DO2、DO3、 DO4、DO5、DO6、DO7、 DO8 (prevail in actual display)
Low-low alarm LL	Low-low alarm value	-99999~99999
Low alarm delay	Low alarm delay	0 s, 10 s, 30 s, 60 s, 120 s, 180 s, 240 s.
Low-low alarm LL	Low-low alarm output terminals	None、DO1、DO2、DO3、 DO4、DO5、DO6、DO7、 DO8 (prevail in actual display)
Hysteresis	Alarm hysteresis	-99999~99999

Note: hysteresis is designed to prevent repeated alarm due to vibration of measurement value around alarm point. Figure 4-1 is a legend of high and low alarm and hysteresis. Upon high alarm, when the actual engineering value is

greater than or equal to the alarm value, the recorder enters the alarm state. When the input decreases, the actual engineering value is less than the alarm value, and the recorder will not immediately exit the alarm state, but until the actual engineering value is less than the difference between the alarm value and the hysteresis value, the recorder will exit the alarm state. So is low alarm.

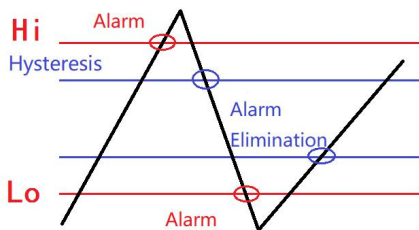

Fig.4-1 high alarm, low alarm and hysteresis

4.2 Function setting

4.2.1 Communication setting

The instrument supports communication operations with PC, to realize real-time monitoring. The instrument only supports Modbus protocol.

Configuration item descriptions:

Configuration item	Function descriptions	Parameters range
Instrument address	Modbus device address	1~254
Baud rate	Communication rate	9600,57600,115200
Check bit	Communication check	No check, odd number check, even number check, normal 0
Floating point format	Format of floating point number	1234,2143,3412,4321

4.2.2 U disk operation

The instrument supports to save the current configuration to USB disk, or read configuration file in USB disk.

Configuration item descriptions:

Configuration item	Function descriptions	File format
Save instrument configuration	Save current instrument configuration	CFG (.cfg)
Read instrument configuration	Read instrument configuration in USB disk. Note: instrument configuration is scanned when USB disk inserted. The newly saved configuration will only be displayed after re-inserting USB disk.	

4.2.3 Reset operation

Configuration item descriptions:

Configuration item	Function descriptions
Clear log record	Clear all log record
Clear power-off record	Clear all power-off record
Clear alarm information	Clear all alarm information

4.3 System setting

Configuration item descriptions:

Configuration item	Function descriptions	Parameters range
password	Set password	000000~999999
instrument name	Set instrument name	8 bit character string
system time	Set system time	
time format	Set time format	YY-MM-DD, DD-MM-YY, MM-DD-YY
record interval	Set record interval	1s, 2s, 5s, 10s, 15s, 30s, 1min, 2min, 5min, 10min, 30min, 60min (one second can be recorded for 10 days).
Curvilinear Coordinates	Set Curvilinear Coordinates	Hundred components and quantities
language	Select system language	Chinese/English
Start up page	Set start up page in default	Overview, digital display, history
cycle time	cycle time displayed in display grouping	0s,5s, 10s, 30s
atmospheric pressure MPa	Set atmospheric pressure of instrument	-999999~9999999
Restore to factory configuration	Restore to factory configuration	

Annex 1: Modbus address and examples

Modbus address table:

S/N	Parameters	Parameter type	Register start address (decimal base)	Number of register
1	1st path analog input	floating point	1	2 registers
2	2nd path analog input	floating point	3	2 registers
3	3rd path analog input	floating point	5	2 registers
4	4th path analog input	floating point	7	2 registers
5	5th path analog input	floating point	9	2 registers
6	6th path analog input	floating point	11	2 registers
7	7th path analog input	floating point	13	2 registers
8	8th path analog input	floating point	15	2 registers
9	9th path analog input	floating point	17	2 registers
10	10th path analog input	floating point	19	2 registers
11	11th path analog input	floating point	21	2 registers
12	12th path analog input	floating point	23	2 registers
13	13th path analog input	floating point	25	2 registers
14	14th path analog input	floating point	27	2 registers
15	15th path analog input	floating point	29	2 registers
16	16th path analog input	floating point	31	2 registers
17	17th path analog input	floating point	33	2 registers
18	18th path analog input	floating point	35	2 registers
19	19th path analog input	floating point	37	2 registers
20	20th path analog input	floating point	39	2 registers
21	21st path analog input	floating point	41	2 registers
22	22nd path analog input	floating point	43	2 registers
23	23rd path analog input	floating point	45	2 registers
24	24th path analog input	floating point	47	2 registers
25	25th path analog input	floating point	49	2 registers
26	26th path analog input	floating point	51	2 registers
27	27th path analog input	floating point	53	2 registers
28	28th path analog input	floating point	55	2 registers
29	29th path analog input	floating point	57	2 registers
30	30th path analog input	floating point	59	2 registers
31	31st path analog input	floating point	61	2 registers

32	32nd path analog input	floating point	63	2 registers
33	33rd path analog input	floating point	65	2 registers
34	34th path analog input	floating point	67	2 registers
35	35th path analog input	floating point	69	2 registers
36	36th path analog input	floating point	71	2 registers

Example of Communication

Example 1: read real-time value of analog input 1

Distributed data:

01 03 00 01 00 02 95 CB

Description:

01: instrument address (configuration can be changed)

03: Modbus 03 command

00 01: register address 3

00 02: Number of registers 2

95 BC: CRC check

Return data:

01 03 04 42 C8 00 00 6F B5

Description:

01: instrument address

03: Modbus 03 command

04: Return data four bytes

42 C8 00 00: Floating point(F4321, configuration can be changed), meaning 100.0

6F B5: CRC check